

* 所有原料材质, 生产制程, 电镀必须符合ROHS要求

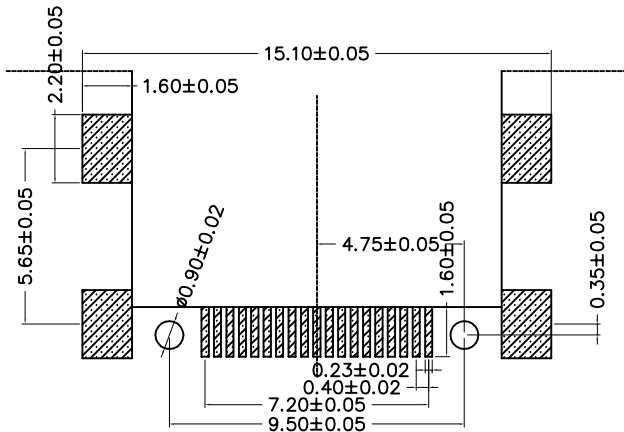
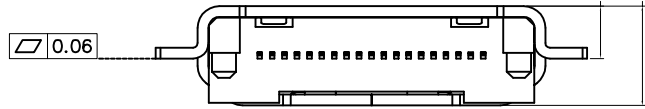
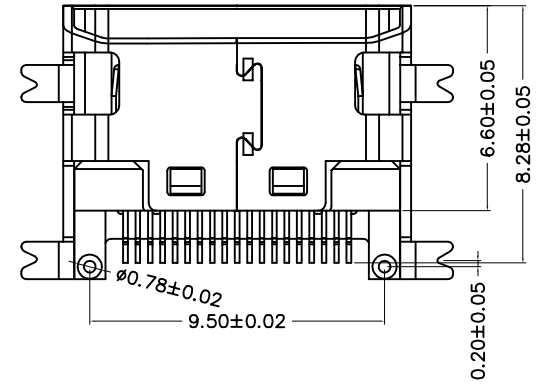
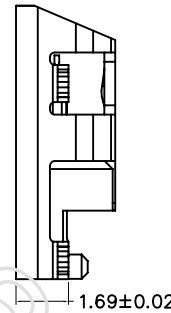
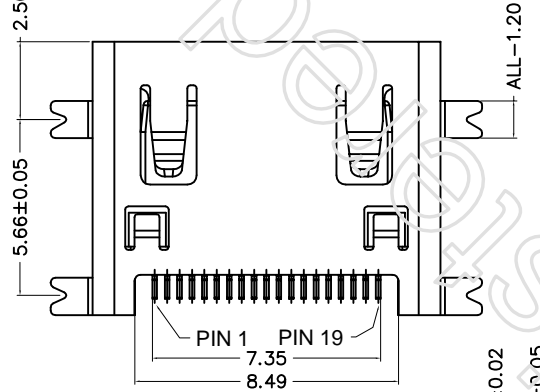
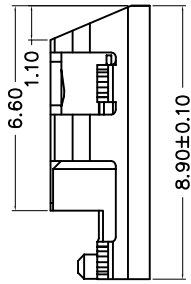
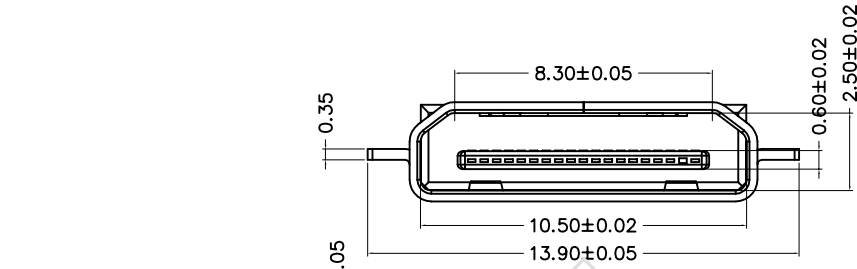

- SPECIFICATION:
- 1.MATING FORCE:44.1N MAX
 - 2.UNMATING FORCE:7-25N
 - 3.DURABILITY: 5000 CYCLES MIN
 - 4.CURRENT:0.5A
 - 5.VOLTAGE:40V MAX
 - 6.WITHSTANDING VOLTAGE:500V AC MIN.(UNMATED)
 - 7.CONTACT RESISTANCE:30MΩ MAX.
 - 8.INSULATION RESISTANCE:100MΩ MIN.(UNMATED)
 - 9.OPERATING TEMPERATURE RANGE:-20.C TO +85.C
 - 10.ALL THE MATERIAL SHOULD COMPLY WITH THE ROHS REQUIREMENT.

Type C pin	Signal Name
1	TMDS Data2_Shield
2	TMDS Data2+
3	TMDS Data2-
4	TMDS Data1_Shield
5	TMDS Data1+
6	TMDS Data1-
7	TMDS Data0_Shield
8	TMDS Data0+
9	TMDS Data0-
10	TMDS Clock_Shield
11	TMDS Clock+
12	TMDS Clock-
13	DDC/CEC Ground
14	CEC
15	SCL
16	SDA
17	Utility
18	+5V Power
19	Hot Plug Detect

深圳市鑫南天科技有限公司

Shen zhen Shi Xin Nan Tian Industrial Co., Ltd

DIMENSIONS INIT: mm
UNLESS OTHERWISE SPECIFIABLE
DIMENSION TOLERANCE
X.X: ± 0.25
X.XX: ± 0.10
X.XXX: ± 0.05
ANGULAR: ± 1°

PRODUCT NAME :
MINI-HDMI 19Pin C TYPE沉板 (鑫南天版本2)
PRODUCT NO. :
0091BAAG19Q9
DRAWING NO. :
XNT-009

DRAWING: COCO
CHECK: JANY
APPROVED: JEFF
DATE: 2009/12/10
DATE: 2009/12/10
DATE: 2009/12/10

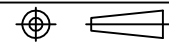

SCALE: 1:1
DWG ID: P D
REV.: A
PAGE: 1 of 1

REVISION NO.	ECR NO.	DESCRIPTION	MARK	DATE
1				
2				