

* All Raw Material, Manufacturing, Plating process comply with ROHS

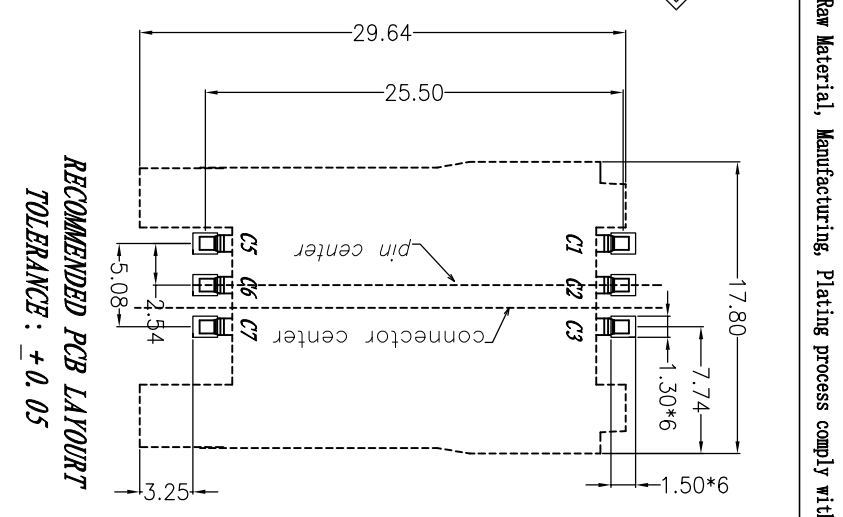

RECOMMENDED PCB LAYOUT
TOLERANCE : + 0.05

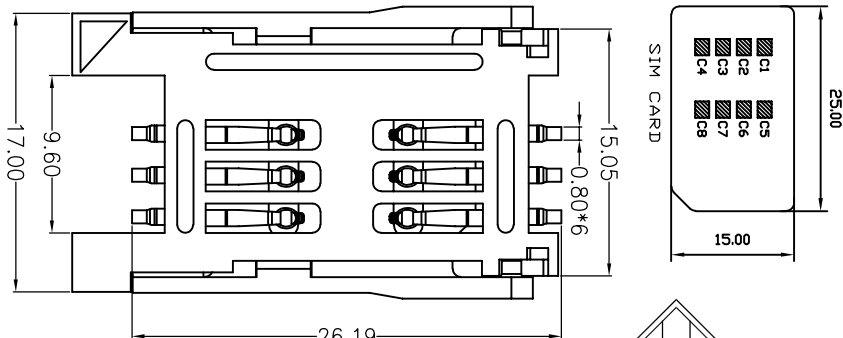
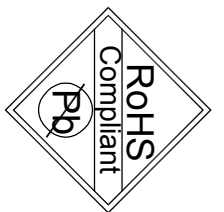
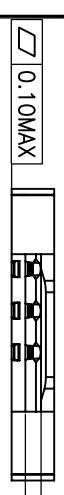
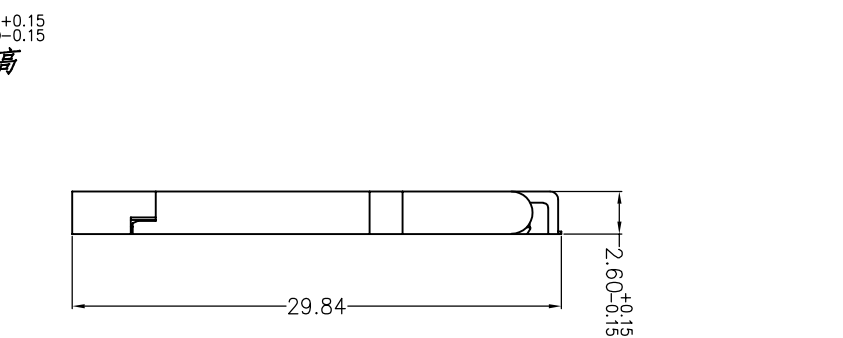
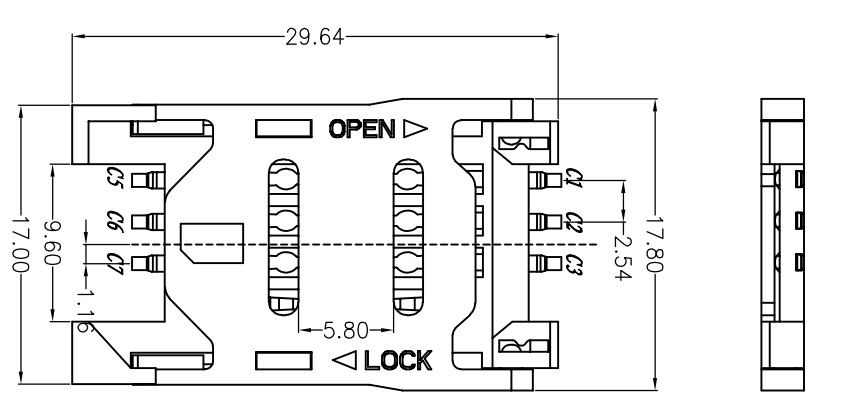

0.85^{+0.15}
0.15^{-0.15}
公差

Technical Specialty

技术特性
Rated Voltage: 50V AC/DC Max
Current Rating: 1.0A Max
Insulation Resistance: 1000MΩ Min
Contact Resistance: 100mΩ Max
Withstand Voltage:
耐压: 500V AC/minute
Operating Temperature: -40℃ ~ +85℃
工作温度: -40℃ ~ +85℃

REMARKS:

附注:
1. MATERIAL:
1.1 HOUSING: THERMOPLASTIC
COLOR: WHITE
颜色: 白色/黑色
1.2 COVER: THERMOPLASTIC
COLOR: WHITE
颜色: 白色/黑色
2. PLATING:
2.1 CONTACT:
NICKEL AND 50μ" MIN CONTACT 1μ" PAD TIN 50μ" /MIN
接触件: 镀镍50μ", 接触点金1μ", 焊脚镀50μ".

SIM卡引脚功能定义

触电极号	分 配	触电极号	分 配
C1	电源电压 VCC	C5	地 GND
C2	复位 RST	C6	编程电压 VPP
C3	时钟 CLK	C7	输入/输出 I/O
C4	不提供触点	C8	不提供触点

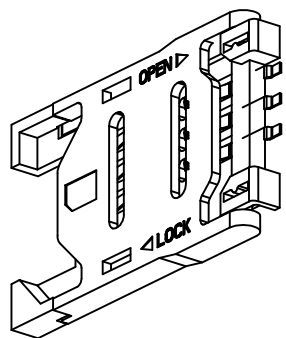

深圳市鑫南天科技有限公司
Shen zhen Xin Nan Tian Technology Co., Ltd

PRODUCT NAME: SIM标准式 5pin	DATE: 2017/11/10
PRODUCT NO.: 043144AS064	DATE: 2017/11/10
DRAWING NO.: 043	DATE: 2017/11/10

UNLESS OTHERWISE SPECIFIABLE	TOLERANCE	SCALE: 1:1	DRW. NO.: C.D	REV.: A	PAGE: 1 of 1
DIMENSIONS INT:	0.15	SCALE:	DRW. NO.:	REV.:	PAGE:
X.X ±	0.10				
X.XX ±	0.05				
ANGULAR ±	1°				